

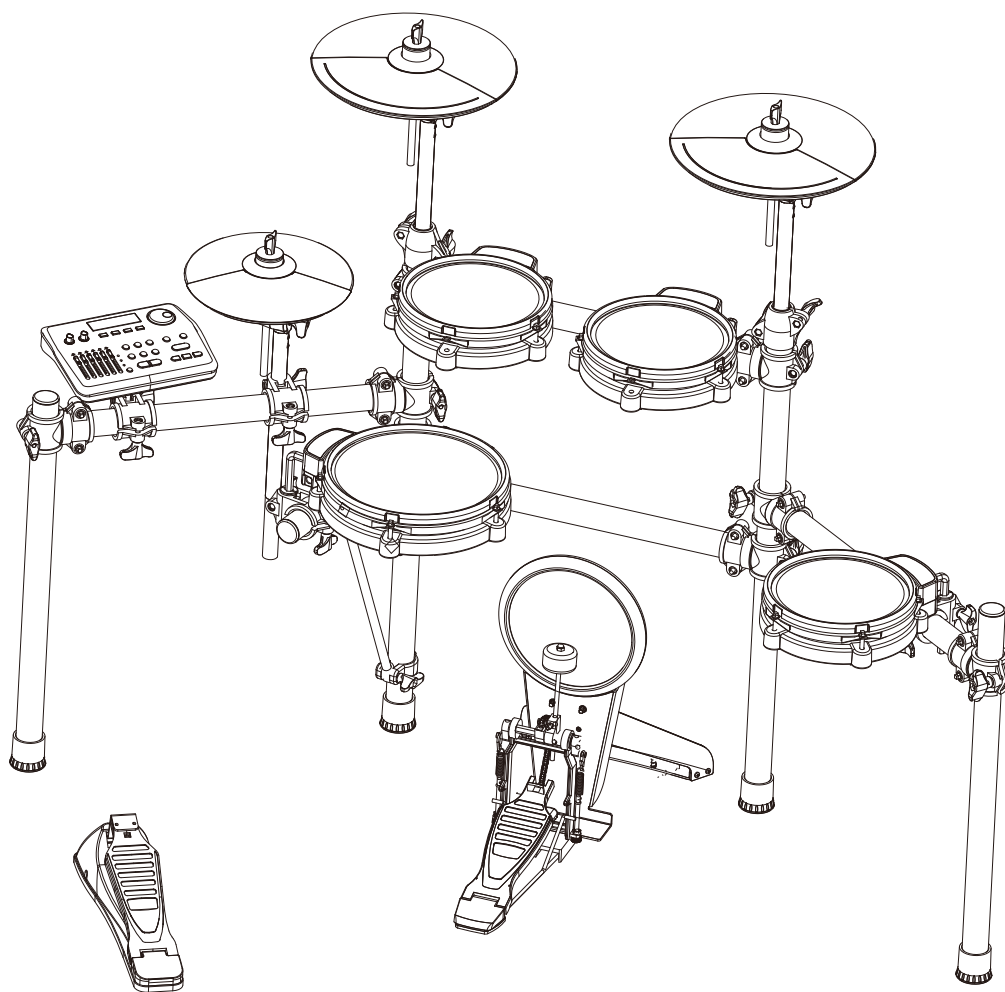

XD-450A DIGITAL DRUM

USER' S MANUAL



CAUTION

CAUTION

Any changes or modifications in construction of this device which are not expressly approved by the party responsible for compliance could void the user's authority to operate the equipment.

WARNING

When using electrical products, basic safety precautions should always be followed, including the following:

NOTE: This equipment has been tested and found to comply with the limits for a Class B digital device, pursuant to Part 15 of the FCC Rules.

Also, this equipment has been tested and found to comply with the limits for following standard:

EN55022-2006

EN55024:1998/+A1:2001/+A2:2003

EN55013:2001/+A1:2003/+A3:2006

EN55020:2007

EN61000-3-2:2006

EN61000-3-3:1995/+A1:2001/+A2:2003

These limits are designed to provide reasonable protection against harmful interference in a residential installation. This equipment generates, uses, and can radiate radio frequency energy and, if not installed and used in accordance with the instructions, may cause harmful interference to radio communications. However, there is no guarantee that interference will not occur in a particular installation. If this equipment does cause harmful interference to radio or television reception, which can be determined by turning the equipment off and on, the user is encouraged to try to correct the interference by one or more of the following measures:

- Reorient or relocate the receiving antenna.
- Increase the separation between the equipment and receiver.
- Connect the equipment into an outlet on a circuit different from that to which the receiver is connected.
- Consult the dealer or an experienced radio/TV technician for help.

TAKING CARE OF YOUR DRUM

! DO NOT ATTEMPT TO OPEN THE UNIT OR MAKE ANY CHANGE IN THE CIRCUITS OR PARTS OF THE UNIT.

SERVICE AND MODIFICATION

This product should be serviced by qualified

service personnel when,

- ◆ the power supply cord or the plug has been damaged,
- ◆ liquid has been spattered into the unit or it has been exposed to rain,
- ◆ the instrument does not appear to operate normally or exhibits a marked change in performance,
- ◆ the instrument has been dropped or the cabinet has been damaged.
- ◆ Do not attempt to open the unit or make any change in the circuits or parts of the unit.

HANDLING AND TRANSPORT

- ◆ Never apply excessive force to the controls, connectors, pads or other parts of the instrument.
- ◆ Always unplug cables by gripping the plug firmly, not by pulling on the cable.
- ◆ Physical shocks caused by dropping, bumping, or placing heavy objects on the instrument can result in scratches and/or more serious damage.
- ◆ Carefully check the amplifier volume control before starting to play. Excessive volume can cause permanent hearing loss.

CLEANING

- ◆ Clean the unit with a dry or light-wet soft cloth.
Do not use paint thinner or petrochemical based polishes.

LOCATION

Do not expose the drum to the following conditions to avoid deformation, discoloration, or more serious damage,

- ◆ direct sunlight (near a window),
- ◆ high temperatures (near a heat source, outside, or in a car during the daytime),
- ◆ excessive humidity,
- ◆ excessive dust,
- ◆ strong vibration.
- ◆ The drum contains digital circuitry and may cause interference if placed too close to radio or television receivers. If interference occurs, move the drum further away from the affected equipment.

POWER

- ◆ Turn the power switch off when the drum is not in use.
- ◆ To avoid damage to the drum and other devices to which it is connected, turn the power switches of all related devices off prior to connection or disconnection of audio cables.
- ◆ Turn the power off if the main cable is damaged or the instrument is spattered with liquid.
- ◆ Do not switch the unit on and off in quick succession, this places an undue load on the electronic components.
- ◆ Unplug the AC power cord during an electrical storm.
- ◆ Avoid plugging the AC adaptor into the same AC outlet as appliances with high power consumption, such as electric heaters or ovens.

CONTENTS TABLE

INSTALLATION	1
SOUND MODULE	6
Control Panel	6
Connectors	9
PLAYIN PAD	10
BEFORE START PERFORMANCE	11
BASIC OPERATION	12
Select Kit	12
Edit a Kit	12
Play a Drum Pattern (Demo song)	12
Record a Drum Track	13
Use the Mixer	13
Restore Factory Settings	13
SETUP	14
Back Volume	14
Tune	14
Local	14
FX Set	14
MIDI Set	15
Advanced Settings	15
Sensitivity	15
Headroom	15
Sense Time.....	15
Trigger Curve.....	15
Cross Talk	16
Note Send	16
Rim Velocity.....	16
Pedal Velocity.....	16
Calibration.....	16
Reset	16
DRUM KIT EDIT	17
Voice Type	17
Voice	17
Volume	17
Reverb	17
Pitch	17
Pan	17
APPENDIX	19
Kit List	19
Pattern List	19
Voice List	20
SPECIFICATIONS	25

INSTALLATION

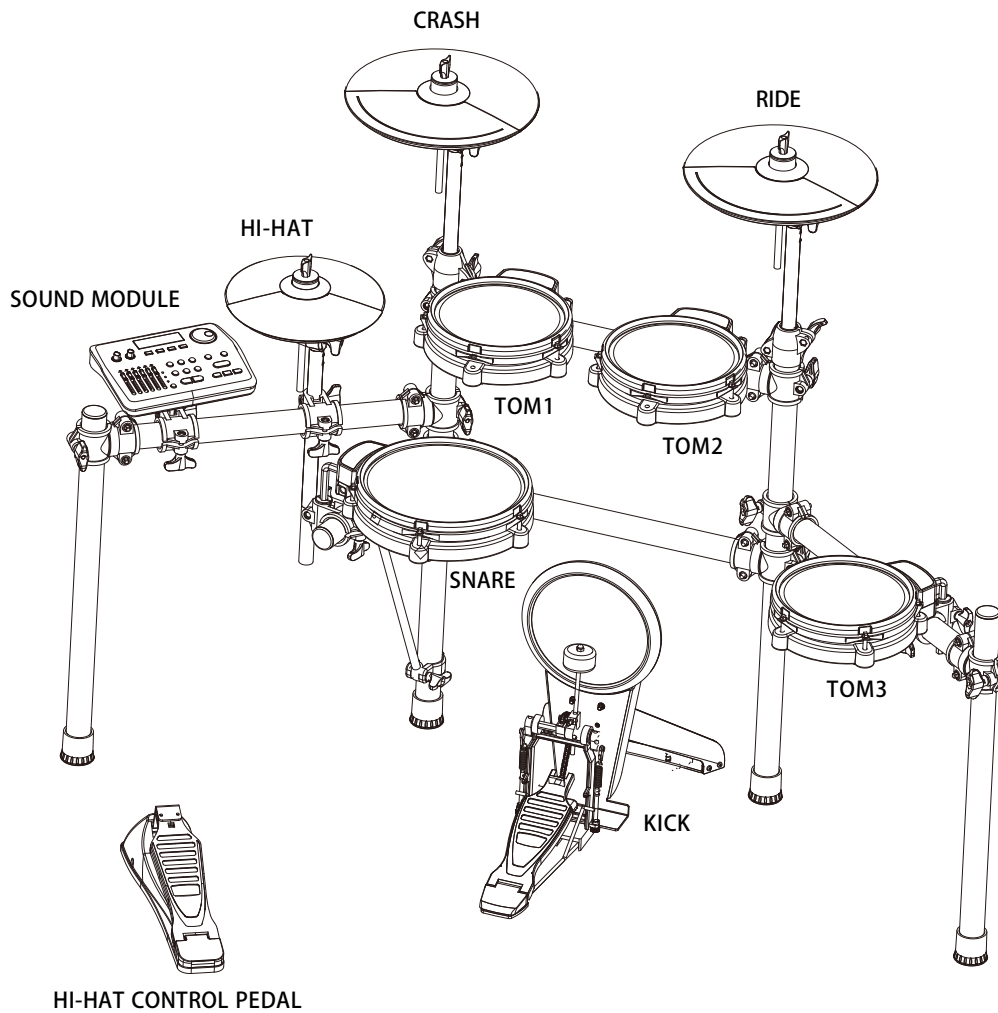

The diagram shows complete drum kit after installation.

Power adaptor and connection cables are not shown in the diagram.

INSTALLATION

RACK INSTALLATION - 1

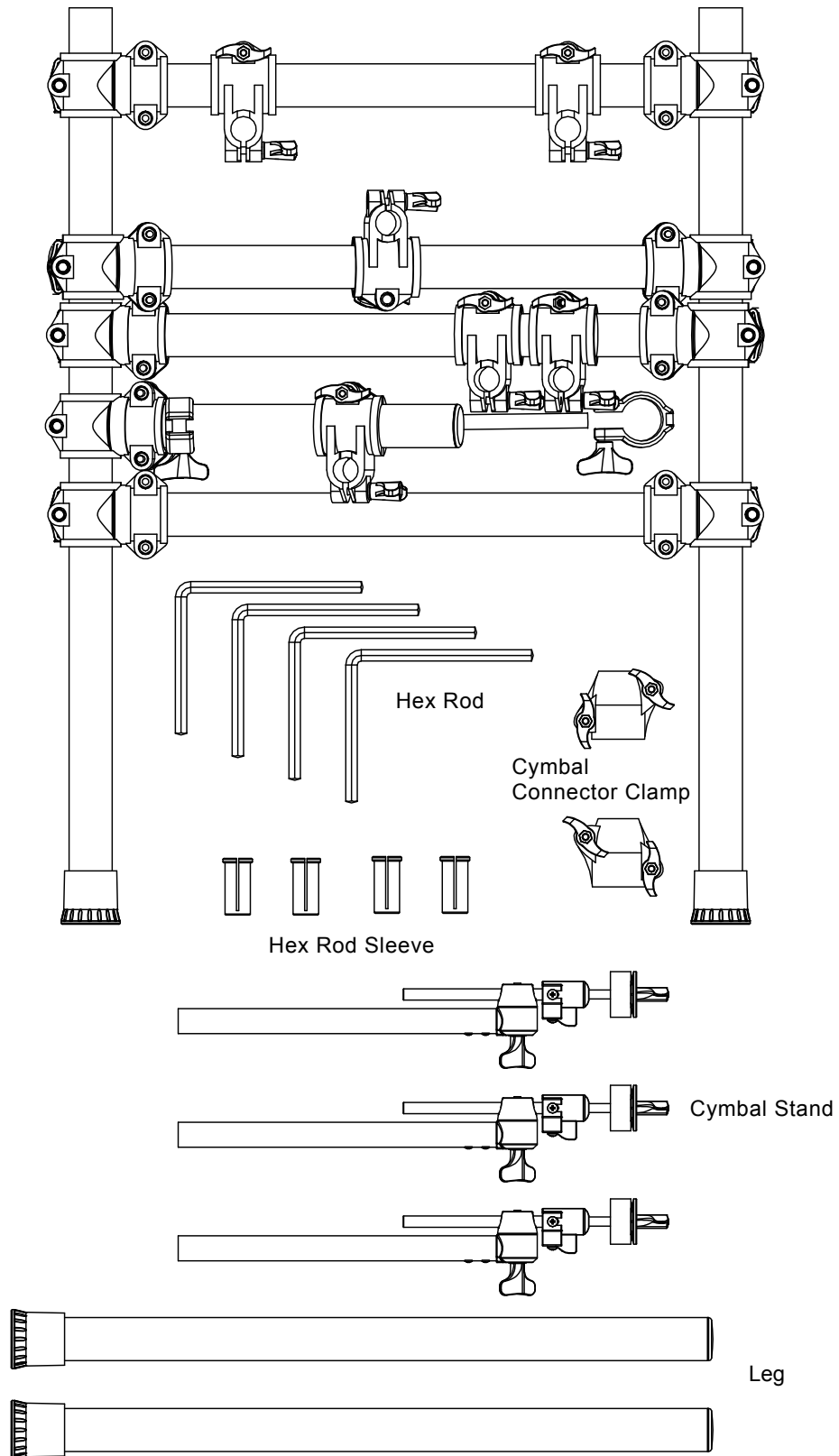

This is the view of all separated parts. Set up the drums according to the diagram on next page.

INSTALLATION

RACK INSTALLATION - 2

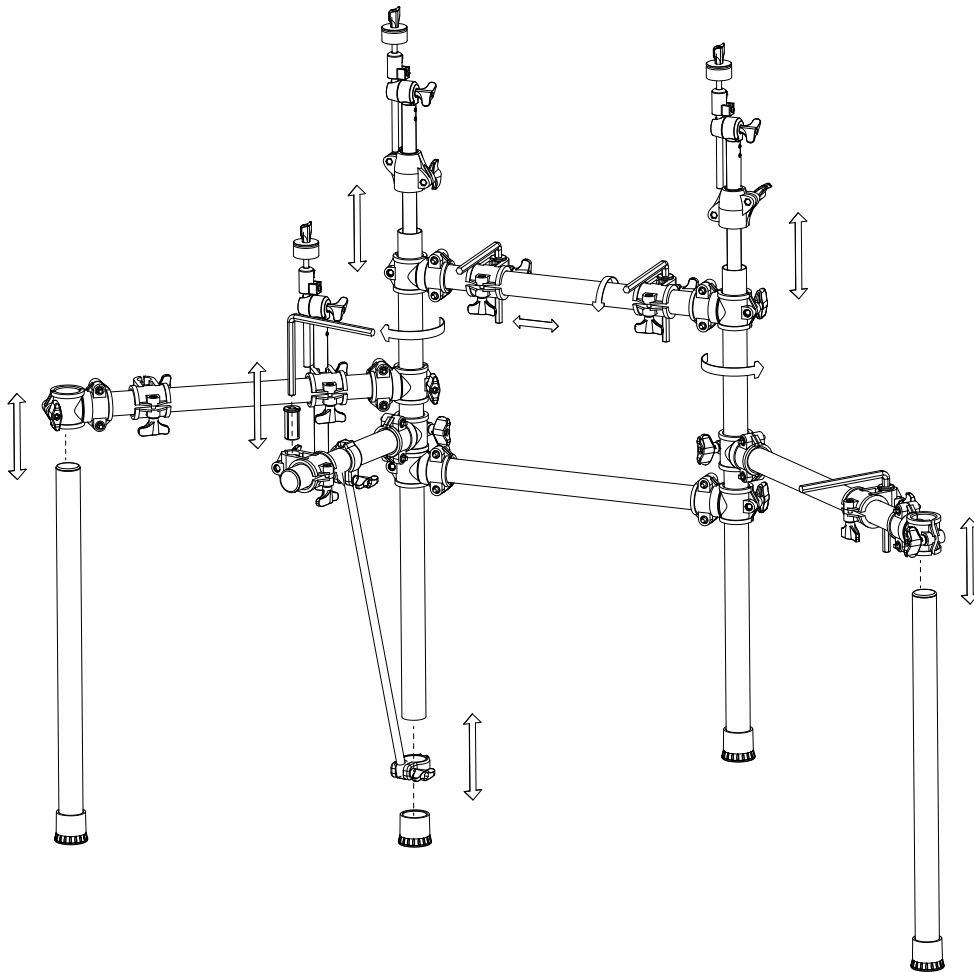

1. Stretch the drum rack according to the picture and install both legs. Take off the rubber foot on middle left leg, and insert the snare bracing-rod into it. After that put the rubber foot back on. Make sure the drum rack stand upright and then fasten wing nuts.
2. Install cymbal connector clamps on middle legs. Then insert cymbal stands to their clamps. Fasten their wing nuts.
3. Insert hex rod sleeves into pad clamps, and then insert hex rods into them.
4. Adjust all parts to a comfortable position when playing seated. Make sure all parts are fasten tight according to next page.

INSTALLATION

RACK INSTALLATION - 3

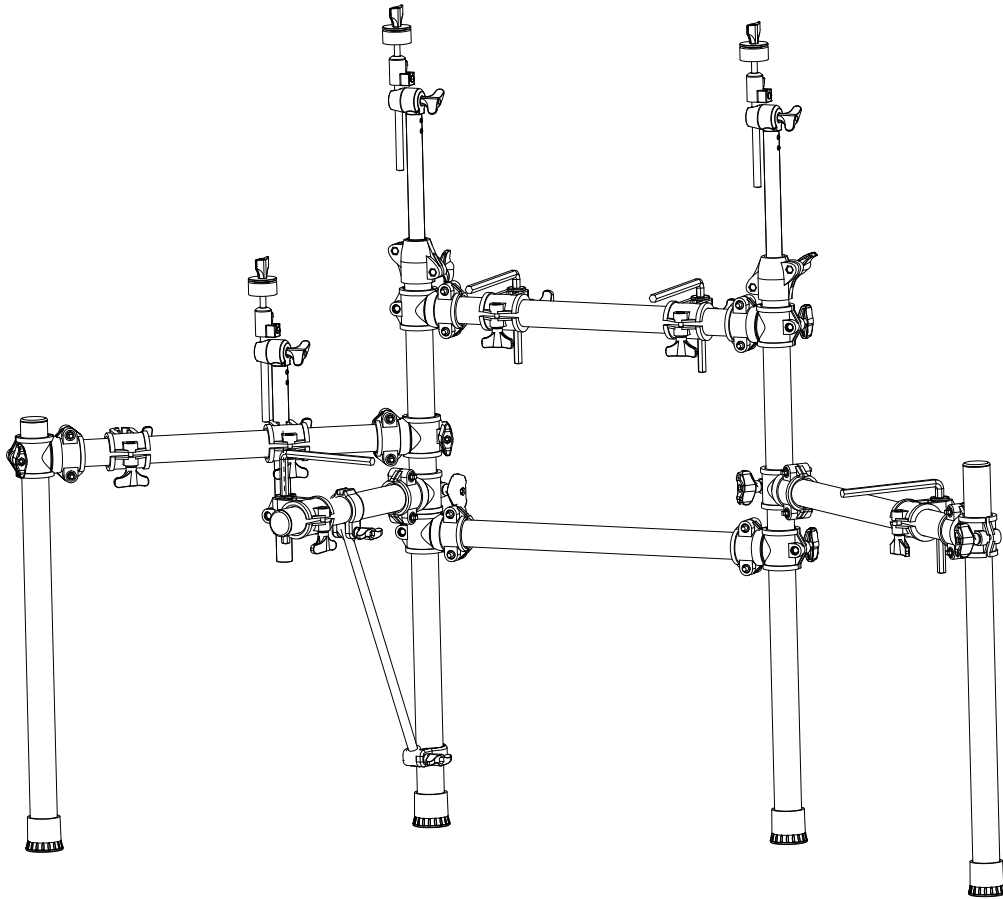

This diagram shows the completely installed drum rack.
Please check the rack with part numbers before you start pad installation.

INSTALLATION

COMPONENTS INSTALLATION

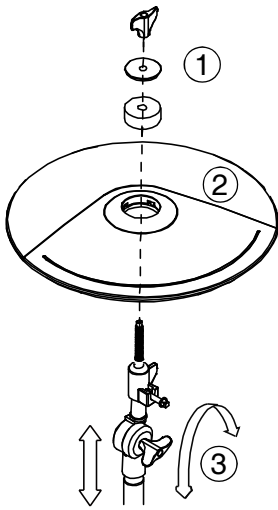

Cymbal Installation

1. Remove the wing nut, washer and felt pad from the top of the rod.
2. Put the cymbal pad into the rod, then place back parts removed in the step 1. Fasten the wing nut but not too tightly. It allows the pad a little bit wobbling like real acoustic cymbal.
3. Adjust the pad position then re-tighten the wing nut.

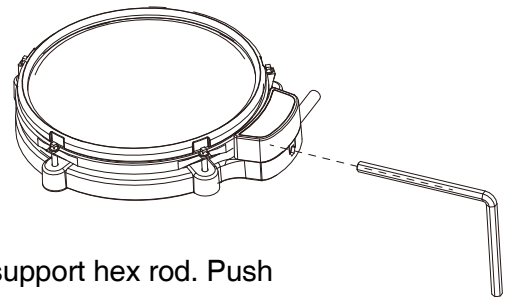

Snare & Tom pad Installation

1. Adjust the support hex rod to suitable position.
2. Loosen the bottom wing nut of the pad and insert it to the support hex rod. Push the wing nut up a little bit and shake the pad to insert it successfully.
3. Fasten the bottom wing nut after the pad is adjusted to the suitable position

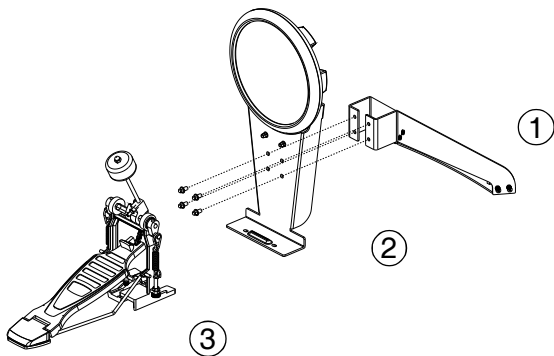

Kick Installation

1. Align holes in the support stand ① and pad ②, then insert bolts and fasten with drum key(attached).
2. Insert tongue ③ of the kick stand into slot of the pedal .
3. Adjust to a suitable position, and then fasten the wing nut on the kick pedal.

Sound module Installation

1. Align holes in the sound module and the model mount then insert screws and fasten it.
2. Insert rod of the model mount into the clamp, then tighten the wing nut.

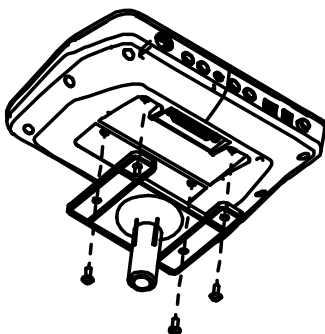

Finalizing the Installation

After install all components, fine adjust the arm, clamps and rods to the best position you desire.

Electronic Connection

Connect the trigger connector cable plug to the bottom of the sound module, and then connect all cable heads according to their name tags.

SOUND MODULE

Control Panel

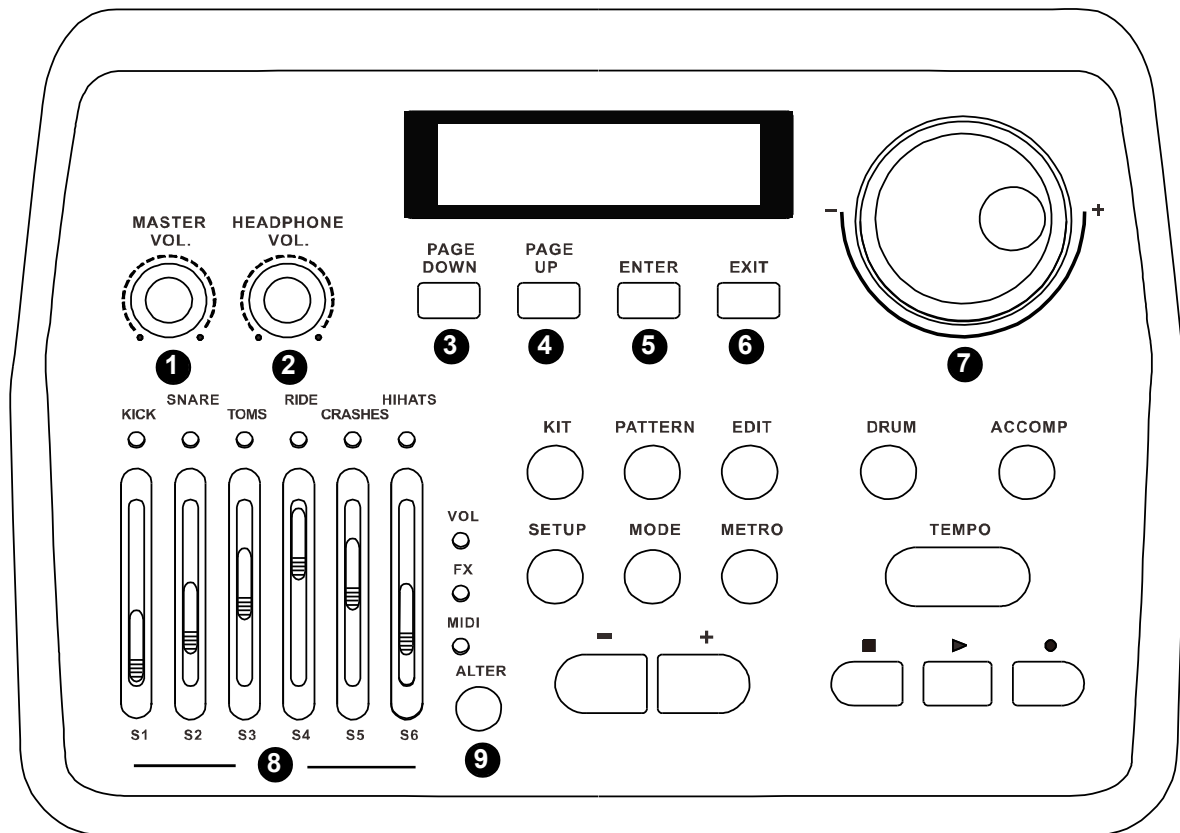

1. MASTER VOL.: Adjust the output level of LINE OUT. Rotate it clockwise to increase volume.
2. HEADPHONE VOL.: Adjust the output level of HEADPHONE , rotate it clockwise to increase volume.
3. PAGE DOWN: Switch to next option in current menu. Can be used when you see ♯ on screen.
4. PAGE UP: Switch to last option in current menu.Can be used when you see ♯ on screen.
5. ENTER: Proceed to submenu or to confirm operation.
6. EXIT: Proceed to root menu or to cancel operation.
7. SCROLL WHEEL: Turn this wheel to increase or decrease values or change kits quickly. Rotate it clockwise to increase.
8. MIXER & 9. ALTER: Use ALTER button to switch 3 fader modes.
 - In VOL mode: S1-S6 are used to control volume of kick, snare, toms, ride, crashes, hi-hats, and also their rim or edge volume.
 - In FX mode: S1 controls kit reverb level. Reverb type can be selected in FX SET menu. S2 controls kit compression ratio. Threshold can be set in FX SET menu. S3-S6 control the gain of a 4-band equalizer. Frequency can be set in FX SET menu. See the SETUP chapter for more information.
 - In MIDI mode: S1-S6 are assigned to 6 different midi controller. They can be used to control track volume or effects on computer. Controller number can be set in MIDI SET menu. (See chapter SETUP).

SOUND MODULE

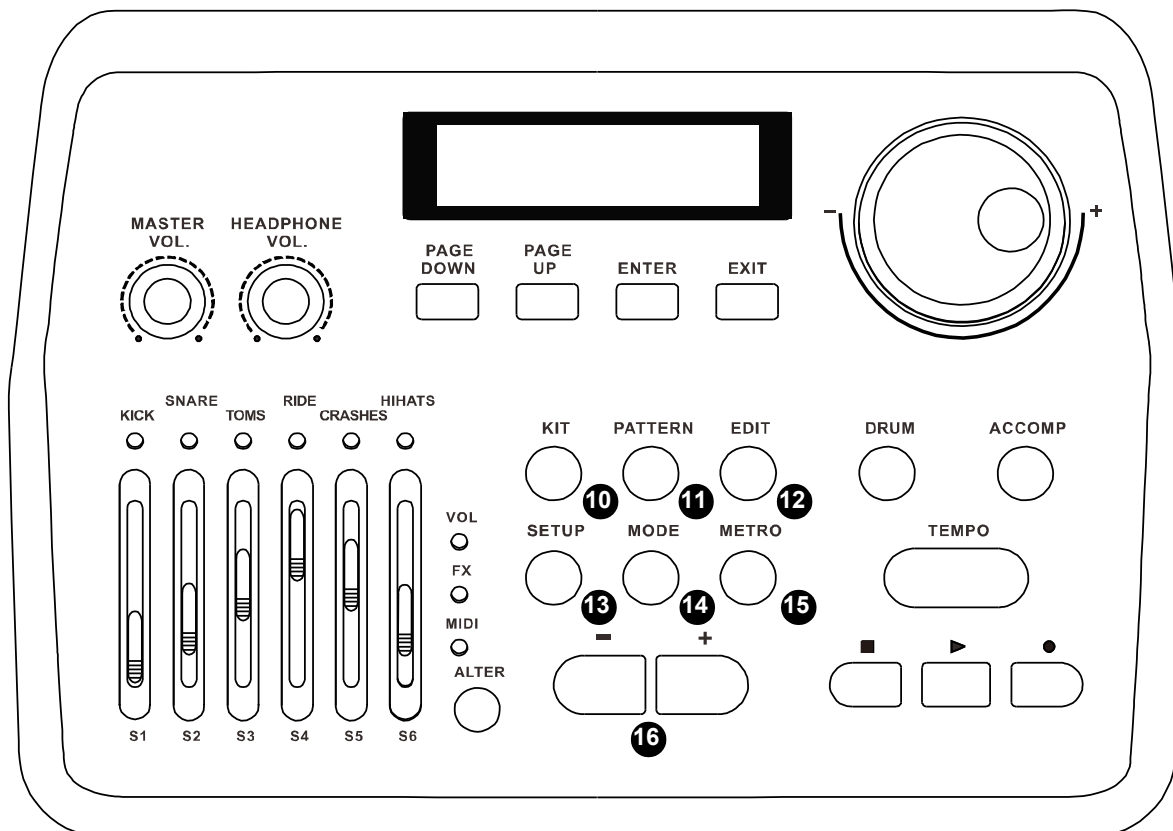

10. **KIT**: Press this button to engage kit mode. You can use +/- button(15/16) or scroll wheel(7) to select a kit in this mode.

11. **PATTERN**: Press this button to engage pattern mode, where you can play demo patterns, exercise with patterns or do some drum recording.

12. **EDIT**: Press EDIT button to edit the current drum kit, including voice type, voice, volume, reverb level, pitch and pan. (See chapter EDIT).

13. **SETUP**: Press SETUP button to adjust system settings, including BACK VOLUME, MASTER TUNE, LOCAL, FX SET, MIDI SET, ADVANCE and RESET. (See chapter SETUP).

14. **MODE**: Change playing modes for demo patterns.

Play One: Play a single pattern once.

Repeat One: Loop a single pattern.

Play All: Play all patterns once.

Repeat All: Loop all patterns.

15. **METRO**: Press this button to set metronome on/off, volume, tempo, time signature and voice. Use PAGE DOWN/UP to switch between options.

16. **-/+**: Use these two buttons to decrease or increase values and settings. Also you can select a kit using these buttons.

SOUND MODULE

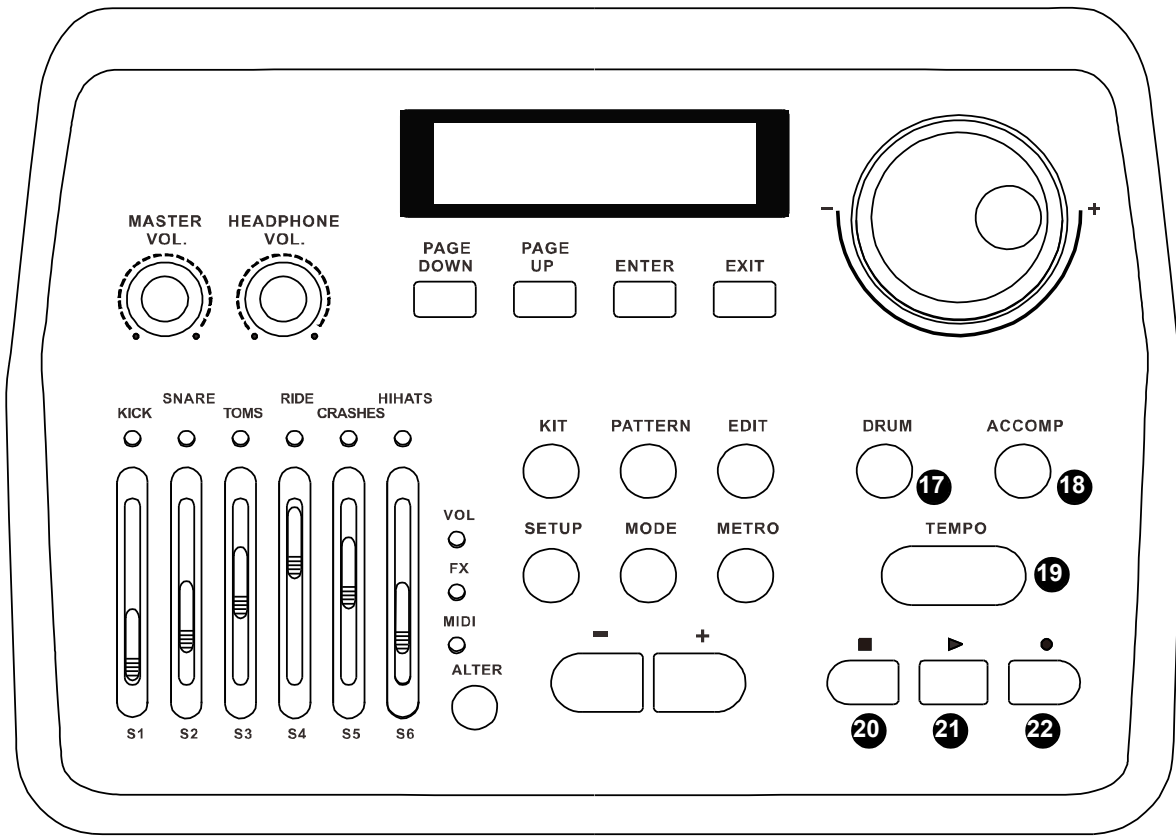

17. DRUM: Press this button to mute the drum track of a demo pattern.
18. ACCOMP: Press this button to mute accompaniment tracks of a demo pattern.
19. TEMPO: Tap this button at a desired rate to get a new tempo for demo pattern and metronome after you have tapped it four times. You can also change the tempo using scroll wheel(7) or -/+ button (16) after you have pressed TEMPO button.
20. ■ : Pauses playback of the current demo pattern, press it again to cancel playing current pattern.
21. ► : Plays the current demo pattern.
22. ● : Record a drum sequence. You can use STOP button (20) to pause recording. Press STOP button (20) again to finish recording and save the sequence to a user song. Press ENTER to confirm. You can also record along with a demo pattern in PATTERN mode.

SOUND MODULE

Connectors

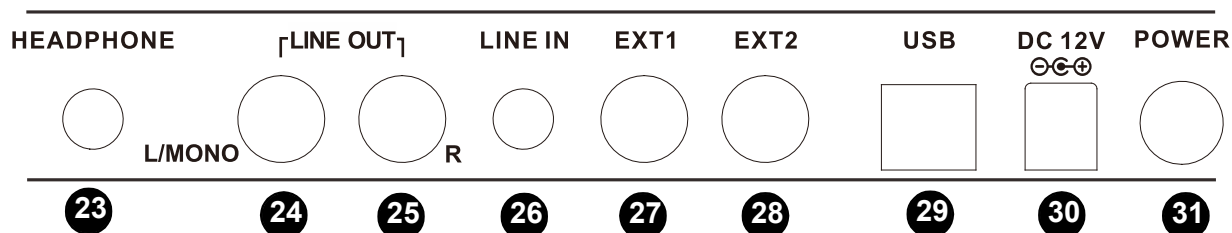

23. HEADPHONE: Connect your headphone here. 1/8" TRS output.

24. LINE OUT L/MONO: Left channel of main output. Connect this output to any amplifier using 1/4" TS cable. For mono output, please connect this socket only.

25. LINE OUT R: Right channel of main output. Connect this output to any amplifier using 1/4" TS cable. For stereo output, please connect both LINE OUT L/MONO (2) and LINE OUT R (3).

26. LINE IN: Analog input socket of the sound module, 1/8" TRS.

TIPS: An extra 1/8" male to male cable will be needed if you want connect your sound module to any sound source such as iPod, iPad, CD player, mobile phone or computer. Play and practice with your favorite music.

27. EXT1: Extended trigger socket 1, connect to Crash2 by default.

28. EXT2: Extended trigger socket 2, connect to Tom4 by default.

29. USB: Connect standard B type USB cable to this socket for updating firmware, gaming, recording midi and using plug-ins for more sound on computer.

TIPS: Connect USB2.0 A male to B male cable to this socket, such cable is very common in home printers.

30. DC 12V: Connect the attached DC 12V power adapter to this socket.

31. POWER: Turns the module on and off.

TRIGGER INPUTS: Trigger inputs socket is located at the bottom of sound module. Connect the multi-trigger connector (AKA 25pin connector) to this socket and lock it.

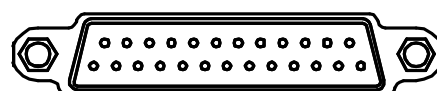

PLAYING PAD

PLAYING PADS

All pads have striking force sensitivity feature. Strike the pad harder to make higher volume and strike the pad softer to make lower volume.

Playing Tom Drum

Strike the central position (head) of the pad to make head sound, strike the rim of the pad to make rim sound.

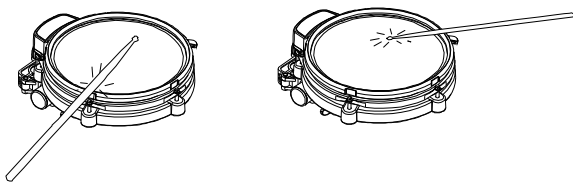

Playing Cymbal

Strike the central position (bow) of the cymbal to make cymbal bow sound, strike the edge of the cymbal to make edge shot sound.

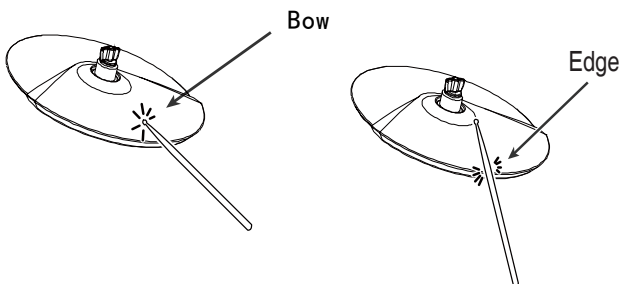

Cymbal Choke

Strike a cymbal, its sound will sustain. Then squeeze the edge portion to mute the sound. Please note that the Hi-Hat has no choke feature.

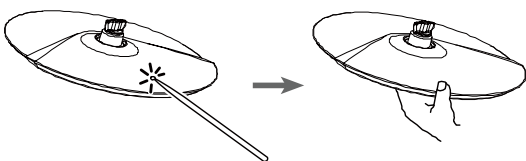

Playing Snare Drum

Strike the central position (head) of the pad to make head sound, strike the rim of the pad to make rim sound. The rim triggering is velocity layered.

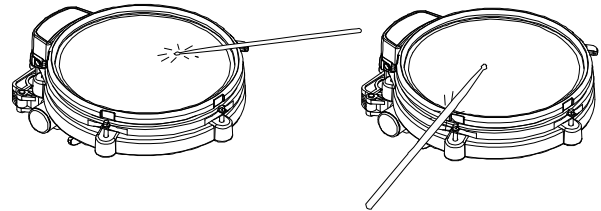

Playing Hi-Hat

- (1) Strike the Hi-Hat pad without pressing the Hi-Hat control pedal to make open Hi-Hat sound.
- (2) Strike the Hi-Hat pad with fully pressing the Hi-Hat control pedal to make close Hi-Hat sound.
- (3) In certain position while you press the Hi-Hat control pedal, playing Hi-Hat cymbal will trigger half open sound.
- (4) Press the Hi-Hat pedal down quickly to make Hi-Hat pedal chick sound.
- (5) Press and release the Hi-Hat pedal down very quick to make Hi-Hat foot splash sound.

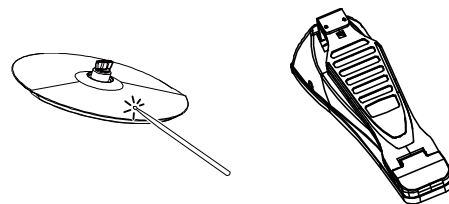

Playing Kick Drum

Press the Kick drum pedal to make kick drum sound.

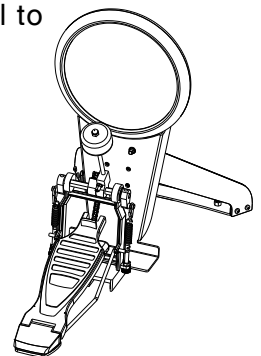



BEFORE START PERFORMANCE

- Make sure the drum kit is stable and all the parts are well locked.
- Connect all the cables to the drum module according to their tags.
- Connect the multi-trigger connector to its socket at the bottom of the sound module and lock it.

- Power the sound module up.

Due to the difference of installation and environment, if cross talk problem occurs, please follow the following procedures.

- Press SETUP button.
- Press the PAGE DOWN/UP button until the sub menu ADVANCE appears.

 **Tip:** When you see  on screen, you can use PAGE DOWN/UP buttons to move to another option.

- Press ENTER button to confirm, then press the PAGE DOWN/UP button to select item of Xtalk.

- Strike a pad you desire with maximum strength repeatedly until "OK" is shown on the screen.

- Then change to another pad and repeat the third procedure (Not including Hihat Pedal).
- Also, you can set the HEADROOM (aka Velocity Dynamic range) of each pad. To reach a loud sound easier, simply lower the HEADROOM value.

- Press EXIT to quit, when "Save Setups" appears, press ENTER to confirm or select No to cancel saving .

 **Note:** All the system settings in SETUP is global parameter, they will affect all the kits and can be saved even when rebooted. If the adjustment result is not good, do a crosstalk reset according to next pages.

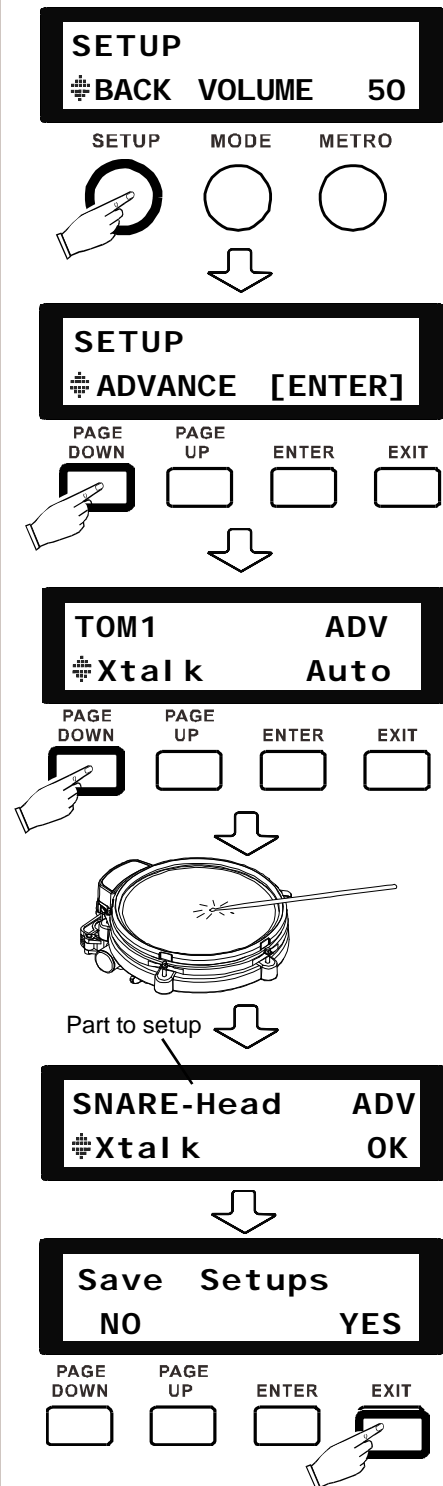

BASIC OPERATION

TO SELECT A KIT

- Press kit on the control panel and use the scroll wheel or -/+ button to select a kit.

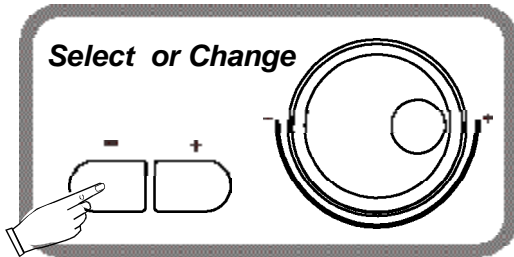

-  **Tip:** While adjusting parameters, you can change its value by using -/+ buttons or scroll wheel also.

TO EDIT A KIT

- Press EDIT to enter EDIT MODE, where you can assign different voices and adjust other parameters to make your own kit. Strike on different part on each pad to select among triggers, or use DRUM button to switch between drum instruments.

- Use PAGE DOWN/UP to enter VOICE TYPE menu and use scroll wheel or -/+ button to choose a voice category. Choose "---" for a blank voice.

- Use PAGE DOWN/UP to enter VOICE menu and use scroll wheel or -/+ button to choose a voice within the selected category referring to Voice List in <APPENDIX> .

-  **Tip:** The meaning of shortened voice names: R stands for Rim shot, X for Cross stick, E for Edge, B for Bell, C for Close, O for Open, Half for Half Open, P for Pedal Chick, Sp for Pedal Foot Splash.

- Use PAGE DOWN/UP to enter VOLUME menu to adjust the volume level for a single trigger.

- Press EXIT to quit the current menu and select a place to save it using +/- button. You can either save it to a preset kit or a user kit if you don't want to overwrite the preset kit. Press ENTER again to confirm or press EXIT to cancel.

TO PLAY A DRUM PATTERN (DEMO SONG)



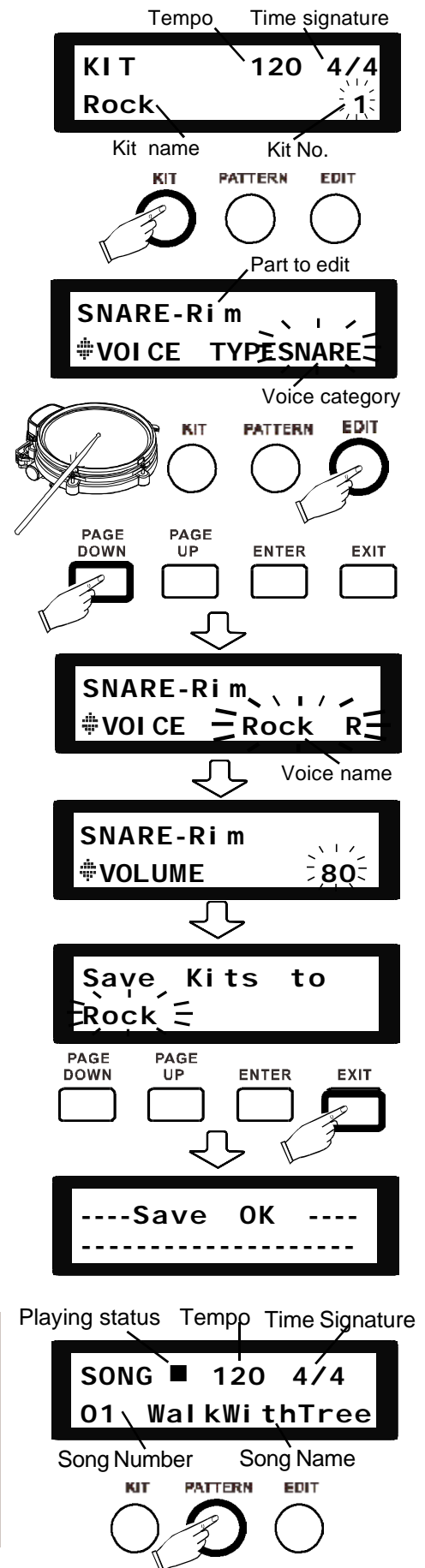

- Press PATTERN button, use scroll wheel or -/+ button to select a demo, and use the play ► and stop ■ buttons to play a demo. The display shows information about demo.



BASIC OPERATION

- Press METRO button, use +/- button or scroll wheel to activate metronome. Use PAGE DOWN/UP to adjust metronome volume, tempo, time signature and sound.
- Tap tempo button at a desired rate to get a new tempo. You can also change the tempo by scroll wheel or +/- button after you press tempo button.
- Don't need the drum track in the demo pattern? Simply press DRUM button to mute it. You can also press ACCOMP button to mute other accompaniment tracks.

TO RECORD A DRUM TRACK

- Press the record button  in KIT mode, set the tempo for recording, and press the record button again to start recording.
- Use stop button  to pause your recording. You can either press play button  to continue recording or press stop button  to finish and save your recording.
- While saving your recording, on the screen will show "Save the song to", use scroll wheel or +/- button to locate the place for saving, and press enter to confirm.
- If you are in PATTERN mode, you can record along with demo song.

TO USE THE MIXER

- Press the ALTER button to switch between 3 modes for faders. In VOL mode, all the faders control the volume of different pads.
- In FX mode, S1 controls reverb level, S2 controls compression ratio, and S3-S6 change to a 4-Bank equalizer.
- In MIDI mode, 6 faders are assigned to 6 different controllers. You can use them to control track volume or various effects in any DAWs or plug-ins.

TO RESTORE FACTORY SETTINGS

- Press SETUP, and use PAGE DOWN/UP to locate RESET menu.
- Use +/- or scroll wheel to select what you want to restore.
 - Kits: Initialize all the kits, including user kits.
 - Settings: Initialize all system settings.
 - Xtalk: Initialize cross talk to default.
 - Songs: Initialize all user patterns.
 - All: Initialize everything to factory settings.
- Press ENTER to confirm. The screen will show RESET OK.
- Reboot the module to complete.

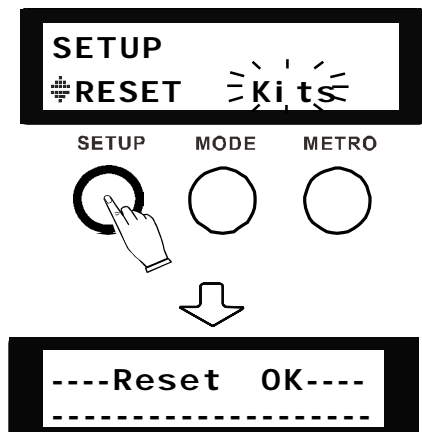
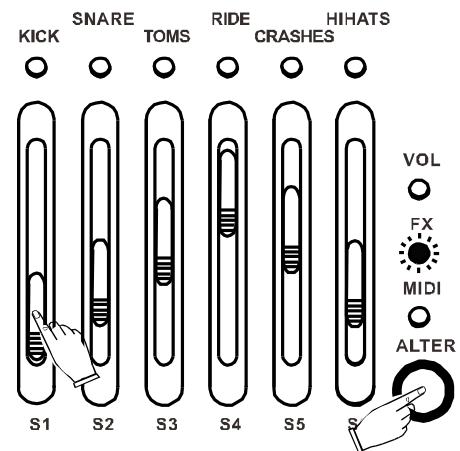
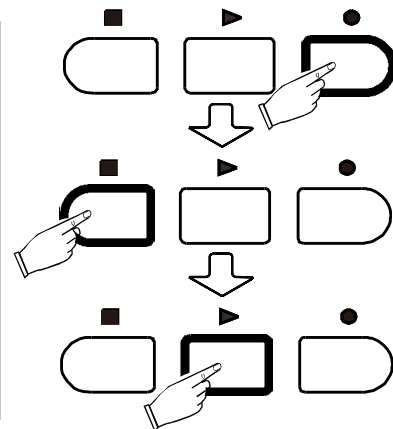
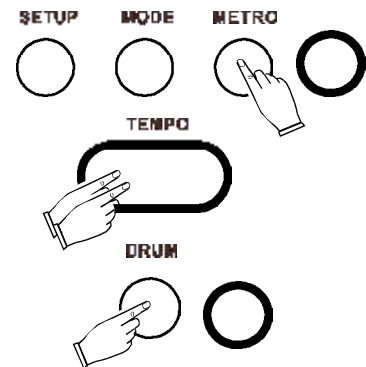

SETUP

Press on the SETUP button to advance to system settings. Use PAGE DOWN/UP to select an item to set.

If the item with blinking parameter, use -/+ button or scroll wheel to change it directly. If the item has [ENTER] mark after, press the ENTER button to enter the sub-menu for further options.

After setting, press the EXIT to exit and the screen shows "Save Setup". Press the ENTER to save or press the EXIT to give up.

All items can be setup are:

BACK VOLUME

Controls the volume of demo patterns and loops.

MASTER TUNE

Controls the overall pitch. It is A4, 440Hz by default.

LOCAL

Decides whether the module read the sound files or not. If switched to OFF, the sound module will function as a midi drum, which produce no sound but send midi messages.

TIPS: If you want to connect the sound module to computer for gaming or using drum plug-ins, switch LOCAL to OFF will lower latency.



Change parameter directly



Press ENTER to enter the sub-menu

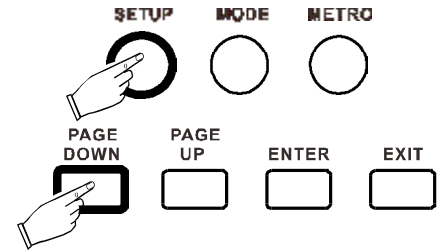

SETUP

ADVANCED SETTINGS

Includes all the physical settings for pads/triggers.

- **Sensitivity:** The higher the value is, the easier it will be to trigger. But if this value is too high, will cause some crosstalk problems.

- **Headroom:** Set the velocity dynamic range. This value is the velocity needed to get max volume, so the lower the value is, the easier to get louder sounds.

TIPS: You can use the faders to adjust the volume quickly, but it will not be saved if you power off the sound module. The concept of Headroom is essentially different from Volume. Headroom decides the velocity to reach the max volume, but cannot change the max level of volume.

- **SenseTime:** Sets the interval between two triggering. Increase this value by certain amount may avoid being triggered multiple times by vibration in very short time.

- **Trigger:** Sets the velocity curve for pads, including Linear, EXP1&2, LOG1&2 and Spline. On horizontal is the velocity you strike, and on vertical is the volume after processed by the trigger curve.

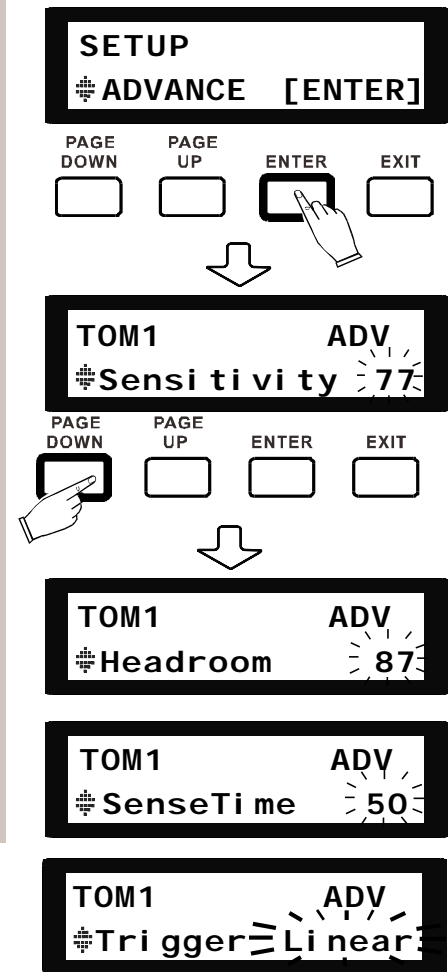
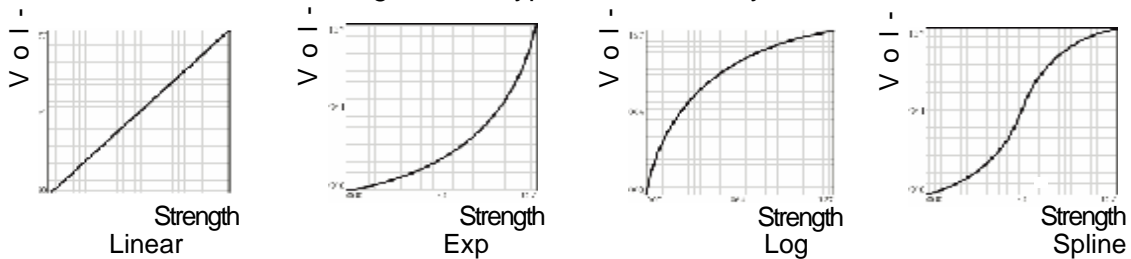

Diagram of 4 types of the velocity curve



- **Xtalk:** Sets the crosstalk for pads. Use max power to strike a pad repeatedly until the screen shows OK, and then change to another pad and repeat the procedure. Velocity data on other pads will be loaded automatically for reference in order to avoid crosstalk.

- **Note Send:** Set the MIDI note for each trigger. When the midi note is different between this module and other sound sources, by adjusting this value they can be easily matched.



SETUP

- **Rim Velocity:** Rim velocity correction option will appear when you strike on the rim or edge parts. The higher the value is, the louder it will become. Cymbal edges are also included in this setting.

- **Pedal Vel.:** Decides the velocity triggered by hi-hat pedal. The higher the value is, the louder Pedal Chick and Pedal Splash sounds you get.

- **Calib:** Calibration for the pedal range. Select this option, press down to the floor and then release the pedal slowly. Repeat the procedure several times to get more precise range and finish the calibration.

- **Spilt Point:** Sets the velocity split point of certain drum. If you play softer than this value, it will trigger one sound. If harder than this value, it will trigger another sound. Each sound can be set separately in parameters.

 **Note:** Some unique settings, such and Rim Velocity, Spilt Point., Pedal Vel., Calib and etc., they will appear only if the matching part is struck. Or you can find them using DRUM button.

 **Tip:** Use DRUM button can switch between triggers quickly in SETUP menu.

RESET: Restore to factory settings. It is strongly recommended to reboot the sound module after reset in completed, in order to avoid some unexpected behavior.

Kits: Initialize all the kits, including user kits.

Settings: Initialize all system settings.

Xtalk: Initialize cross talk to default value.

Songs: Initialize all user patterns..

All: Initialize everything to factory settings.



TOM1-Rim ADV
Rim Velocity 50



Pedal
Pedal Vel. 60

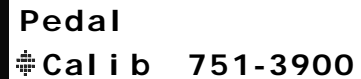

Pedal
Calib 751-3900



SNARE-X-Stick ADV
Split Point 50



SETUP
RESET Kits

DRUM KIT EDIT

First, select a kit for editing. Press on the EDIT button to enter drum kit edit menu. There are 6 items available for kit editing.

The chapter <BASIC OPERATION> instructs how to enter the Edit mode, select part and item in details; this chapter offers more information.

VOICE TYPE: Select the category of the voice, including KICK, SNARE, TOM, RIDE, CRASH, HIHAT, PERC (Percussions and FXs), METRO (Metronome), --- (Blank).

 **Note:** Select "---" for Pedal Splash if you don't need it.

VOICE: Select a voice in its category. Create your own kit with voices you like.

 **Note:** For hi-hats don't have a matching Half-Open sound, please set the HalfOpen voice the same to HIHAT-Open sound.

VOLUME: Adjust the volume of current trigger. The higher the volume, the louder it will be.

REVERB: Adjust the reverb level of current trigger. Overall reverb can be adjusted by S2 in FX mode, this value decides how much the current trigger will be affected by fader S2.

PITCH: Adjust the pitch of current trigger, measured in semi-tones.

PAN: Adjust the panning of current trigger. Minus value stands for left and 0 stands for middle position.

 **Tip:** Use DRUM button can switch between triggers quickly in EDIT menu.

 **Note:** For drum kit settings in EDIT menu, each setting affects one trigger. For multi-triggering pads, they may have many triggers. For example, snare head, snare rim and snare X-stick can have different volume settings.

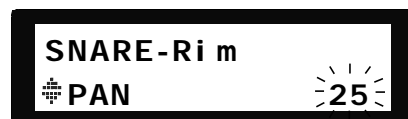
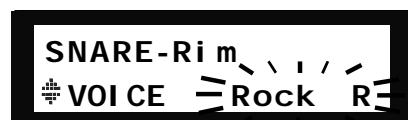
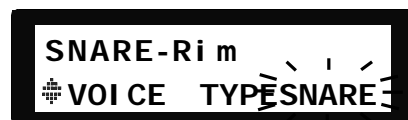
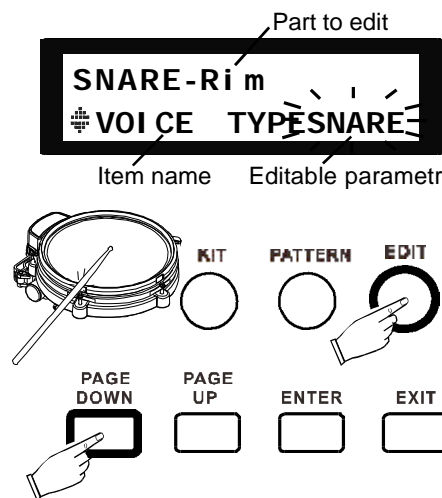

DRUM KIT EDIT

See to the picture below for trigger names:

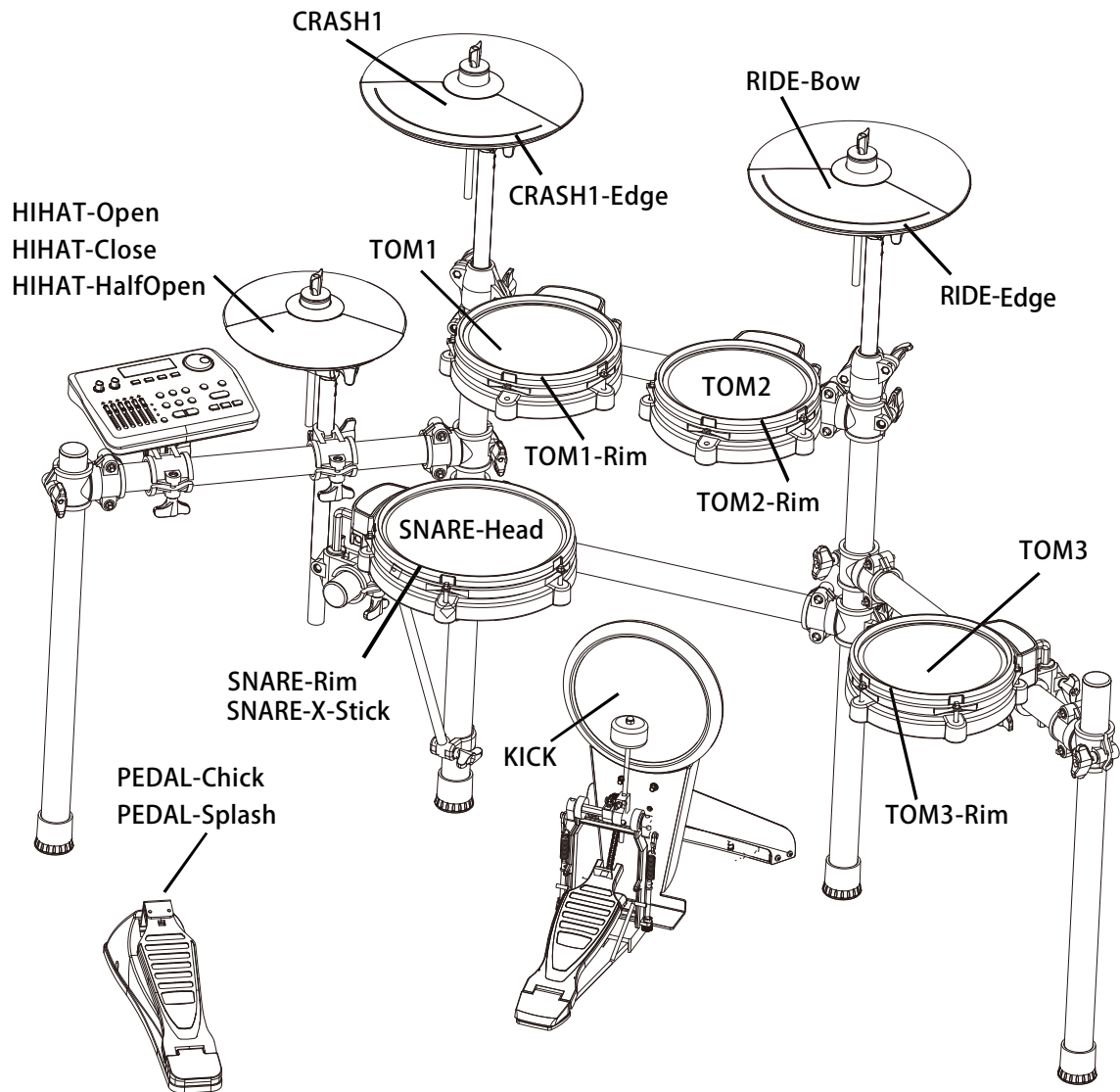

APPENDIX

KIT LIST

1	Studio	8	Latin	15	DirtySouth
2	Funk	9	Brush	16	Nebula
3	Pop	10	Sunray	17	Drumstep
4	Jazz	11	Fiesta	18	Jungle
5	Metal	12	Mario	19	Utopia
6	Rock	13	Impulse	20	BlueBay
7	80s	14	Loop		

In kit 14 Loop, each tom contains a different loop. If you strike on it, a loop will be played. Each loop is in 4 measures. At every fourth measure, if you strike on another tom, a loop will be played automatically in next bar. To stop playing a loop, simply strike on the tom corresponding to the loop current playing.

PATTERN LIST

1	WalkWithTree	20	SoftAmour	39	Bartender
2	Soul	21	MelodicDeath	40	Celebration
3	Latin	22	SambaDance	41	Discover
4	Moskau	23	RockBlues	42	Shade
5	Heart	24	Fly	43	Echo
6	Fable	25	Bossa	44	LiteGroove
7	theStorm	26	Tango	45	River
8	Beowulf	27	Dancing	46	Jazz
9	Forever	28	CryintheRain	47	Love
10	Acid	29	NightTrain	48	Blues
11	Arcane	30	Arriba	49	Techno
12	toBeLoved	31	Batteries	50	OutofMyHeart
13	Rain	32	Revealite	51	MellowTone
14	PopAges	33	Breathe	52	theLight
15	ChaCha	34	BlueEyes	53	Take
16	Life	35	HeyMan	54	Angel
17	Home	36	Firerain	55	Bridge
18	Latina	37	NyanCats		
19	Reality	38	Supreme		

APPENDIX

VOICE LIST (1)

KICK

Rock	Techno 03	Session	Kiss
Jazz	Techno 04	Vintage	DDDclean
Indie 01	Trance 01	Jungle 01	MorMOOG
Indie 02	Trance 02	Jungle 02	Morschlag2
Metal	Trance 03	Fiesta	Morschlag3
Funk 01	Trance 04	Birch 01	Morschlag1
Funk 02	Trance 05	YAM18	Morschlag5
8Bit 01	Trap 01	JAZZ V	Ballerfiako
8Bit 02	Trap 02	METAL V	Rave309
House 01	Trap 03	POP V	Y30
House 02	Trap 04	ROCK2V	SOLI606
House 03	Trap 05	ROCK V	SOLI808
RnB 01	Pop 01	ROCKBRIGHT	Y909
RnB 02	Pop 02	DGs8	Rosa
RnB 03	Pop 03	Pik	KissV
RnB 04	Pop 04	Sax	DG3
Techno 01	Jungle	Six	TR66RIM
Techno 02	Latin	Hot	Soli909RIM

SNARE

Rock	RnB 04	Latin Rimshot 02	POPV SS
Rock Rimshot	RnB R 01	Session	ROCKV2
Rock X	RnB R 02	Session Rimshot	ROCKV2 RS
Jazz 01	RnB X-Stick 01	Session X	ROCKV2 SS
Jazz 01 Rimshot	RnB X-Stick 02	Vintage	ROCKV3
Jazz X-Stick	Techno 01	Vintage Rimshot	ROCKV3 RS
Jazz 02	Techno 02	Vintage X-Stick	ROCKV3 SS
Jazz 02 Rimshot	TechnoC 01	Jungle	ROCKBRI
Indie 01	TechnoC 02	Jungle Rimshot	ROCKBRIRS
Indie Rimshot 01	Trance 01	Fiesta 01	ROCKBRISS
Indie X-Stick	Trance 02	Fiesta R 01	Soli8085
Indie 02	Trance 03	Fiesta X-Stick 01	FatschSd
Indie Rimshot 02	Trance 04	Fiesta 02	MBare
Metal	Trap 01	FiestaRimshot 02	OrgCP
Metal Rimshot	Trap 02	Fiesta Rimshot 03	SoliNoisy
Metal X-Stick	Trap 03	Jungle2	909
Funk 01	Trap 04	Jungle2 R	Abpunch
Funk Rimshot 01	Trap 05	BALLAD1	DD31
Funk X-Stick 01	Trap 06	RSBALLAD1	Dy2
Funk 02	Trap 07	SSBALLAD1	L9

 **Note:** The voice in the list is a full name; some letters are omitted on screen display that is in light grey in the list.

APPENDIX

VOICE LIST (2)

Funk Rimshot 02	Trap 08	BrushV	Morball2
Funk X-Stick 02	Trap 09	BrushVSWIRL	Morballcl
8Bit 01	Trap 10	BrushV RS	X82
8Bit 02	Trap 11	BrushV SS	Soli8084
House 01	Pop	JAZZV	Soli9095
House 02	Pop Rimshot	JAZZV RS	SoliFR2L
House 03	Pop X-Stick	JAZZV SS	Soli808
House 04	Brush	METALV	SoliRH5
House 05	Brush Rimshot	METALV RS	RimY10RIM
RnB 01	Brush X-Stick	METALV SS	RimSoli808R
RnB 02	Latin	POPV	SNSN80er
RnB 03	Latin Rimshot 01	POPV RS	

TOM

Rock1	RnB3	Jungle2	Rim10SoliNat
Rock1 Rimshot	RnB4	Jungle2 Rimshot	Rim12SoliNat
Rock2	Techno1	Jungle3	Rim14SoliNat
Rock2 Rimshot	Techno2	Jungle3 Rimshot	Rim16SoliNat
Rock3	Techno3	Jungle4	10SoliJP1
Rock3 Rimshot	Techno4	Jungle4 Rimshot	12SoliJP1
Rock4	Trance1 01	Fiesta1	14SoliJP1
Rock4 Rimshot	Trance2 01	Fiesta1 Rimshot	16SoliJP1
Jazz1	Trance3 01	Fiesta2	Rim10SoliJP1
Jazz1 Rimshot	Trance4 01	Fiesta2 Rimshot	Rim12SoliJP1
Jazz2	Trance1 02	Fiesta3	Rim14SoliJP1
Jazz2 Rimshot	Trance2 02	Fiesta3 Rimshot	Rim16SoliJP1
Jazz3	Trance3 02	Fiesta4	yt808ana1
Jazz3 Rimshot	Trance4 02	Fiesta4 Rimshot	yt808ana2
Jazz3	Trap1 01	Brush8	yt808ana3
Jazz3 Rimshot	Trap2 01	Brush10	yt808ana4
Indie1	Trap3 01	Brush12	Li_HTO 1
Indie2	Trap1 02	Brush14	Li_HTO 2
Indie3	Trap2 02	BrushRim8	Li_HTO 3
Indie3	Trap3 02	BrushRim10	Li_HTO 4
Metal1	Pop1	BrushRim12	80_TOM1
Metal2	Pop1 Rimshot	BrushRim14	80_TOM2
Metal3	Pop2	10XNMas	80_TOM3
Metal4	Pop2 Rimshot	12XNMas	80_TOM4
Conga1	Pop3	14XNMas	80er1

APPENDIX

VOICE LIST (3)

Conga2	Pop3 Rimshot	16XNMas	80er2
Conga3	Pop4	Rim10XNMas	80er3
Conga4	Pop4 Rimshot	Rim12XNMas	80er4
Conga5	Brush1	Rim14XNMas	NOV_808TOM1
Conga6	Brush2	Rim16XNMas	NOV_808TOM2
Timbale1	Brush3	10BigReverb	NOV_808TOM3
Timbale2	Brush4	12BigReverb	NOV_808TOM4
8Bit1	Latin1	14BigReverb	SDS7_4TO1
8Bit2	Latin2	16BigReverb	SDS7_4TO2
8Bit3	Latin3	Rim10BigRev	SDS7_4TO3
8Bit4	Latin4	Rim12BigRev	SDS7_4TO4
House1 01	Session1	Rim14BigRev	909_TOM1
House2 01	Session2	Rim16BigRev	909_TOM2
House3 01	Session3	10MetaFilter	909_TOM3
House4 01	Session4	12MetaFilter	909_TOM4
House1 02	Vintage1	14MetaFilter	TED_TOM1
House2 02	Vintage1 Rimshot	16MetaFilter	TED_TOM2
House3 02	Vintage2	Rim12MetaFil	TED_TOM3
House4 02	Vintage2 Rimshot	Rim14MetaFil	TED_TOM4
House1 03	Vintage3	Rim16MetaFi	X1_ETOM1
House2 03	Vintage3 Rimshot	Rim10MetaFi	X1_ETOM2
House3 03	Vintage4	10SoliNathan	X1_ETOM3
House4 03	Vintage4 Rimshot	12SoliNathan	X1_ETOM4
RnB1	Jungle1	14SoliNathan	
RnB2	Jungle1 Rimshot	16SoliNathan	

RIDE

Rock	House 01	Jungle Bell	Pst21Ny1
Rock Bell	House 02	Fiesta	Pst21Ny2
Rock Edge	House 03	Fiesta Bell	Pst21 B1
Jazz	RnB	Fiesta Edge	Pst21 B2
Jazz Bell	Techno 01	Pst20Ny1	Pst21 E
Jazz Edge	Techno 02	Pst20Ny2	Pst21Br
Indie	Trance	Pst20Ny B	Pst21Br B
Indie Bell	Pop	Pst20Ny E1	Pst21Br E
Indie Edge	Pop Bell	Pst20Ny E2	Pst21EDGMe
Funk 02	Brush	Pst20Wd	Pst2TNy
Funk Bell 02	Brush Bell	Pst20Wd B	Pst2TNy B
Funk Edge 02	Brush Edge	Pst20Wd E	Pst2TNy E1
Funk 01	Session	Pst20Br	Pst2TNy E2
Funk Bell 01	Vintage	Pst20Br B	
Funk Edge 01	Vintage Bell	Pst20Br E	

APPENDIX

VOICE LIST (4)

CRASH

Rock1	8Bit2	SplashA12	Crash18
Rock1 Edge	House 01	SplashA12E	Crash18 E
Rock2	House 02	SplashB12	CrashB16 E
Rock2 Edge	House 03	SplashB12E	CrashB16 E
RockChina	House 04	Splash8	CrashB16
RockSplash	Trance1	Splash8E	Crash18
Jazz1	Trance2	China12Mal	Crash18 B
Jazz1 Edge 01	Trap1 01	China14Mal	Crash18Br
Jazz2	Trap2 01	China16Mal	Crash18 E1
Jazz2 Edge	Pop1	China20Sti	Crash18 E2
JazzSplash 01	Pop2	China30	Crash20
JazzSplash 02	Session1	Crash14 E	Crash20Beat
Indie1 01	Session2	Crash14	Crash20Br
Indie2 01	Vintage1	Crash16 E	Crash20EDGE
Indie1 02	Vintage2	Crash16	808_1CYM
Indie2 02	Jungle1	Crash17	NOV_CYMB
Funk1 02	Jungle2	Crash17br	Y808crash
Funk2 02	Fiesta1	Crash17 E	
8Bit1	Fiesta2	Crash17	

HI-HAT

Rock Open	House Open 03	Brush Pedal Splash	BalHHSp
Rock Closed	House Closed 03	Session Open	CDHH O
Rock Pedal Chick	RnB Open 01	Session Closed	CDHH C
Rock Half-Open	RnB Closed 01	Session Pedal Chick	CDHH P
Rock Pedal Splash	RnB Open 02	Session Pedal Splash	CDHH Half
Jazz Open 01	RnB Closed 02	Vintage Open	CDHH Sp
Jazz Closed 01	Techno Open 01	Vintage Closed	CCO O
Jazz Pedal Chick 01	Techno Closed 01	Vintage Pedal Chick	CCO C
Jazz Open 02	Techno Open 02	Vintage Half-Open	CCO P
Jazz Closed 02	Techno Closed 02	Vintage Pedal Splash	CCO Half
Jazz Pedal Chick 02	Trance Open 01	Jungle Open	CCO Sp
Indie Open 02	Trance Closed 01	Jungle Closed	808_2HH O
Indie Closed 02	Trance Open 02	Jungle Pedal Chick	808_3HH O
Indie Pedal Chick 02	Trance Closed 02	Jungle Half-Open	808_HH C1
Metal Open	Trap Open 01	Jungle Pedal Splash	808_HH C2
Metal Closed	Trap Closed 01	Fiesta Open	808HH P
Metal Pedal Chick	Trap Open 02	Fiesta Closed	909HHOP2
Funk Open 01	Trap Closed 02	Fiesta Pedal Chick	909_HHCL

APPENDIX

VOICE LIST (5)

Funk Closed 01	Trap Open 03	Fiesta Half-Open	909HHCL2
Funk Pedal Chick 01	Trap Closed 03	Fiesta Pedal Splash	CR78_HHO
Funk Open 02	Pop Open	CCMHH O	CR78_HHC
Funk Closed 02	Pop Closed	CCMHH C	NOV_HHOP
Funk Pedal Chick 02	Pop Pedal Chick	CCMHH P	NOV_1HHC
8Bit Open	Pop Half-Open	CCMHH Half	SakataHH O
8Bit Closed	Pop Pedal Splash	CCMHH Sp	SakataHH C
House Open 01	Brush Open	BalHH O	SakataHH P
House Closed 01	Brush Closed	BalHH C	Y808HH O
House Open 02	Brush Pedal Chick	BalHH P	Y808HH C
House Closed 02	Brush Half-Open	BalHH Half	

PERCUSSION

Cowbell	TranceFX02	Agogo01	808 shaker
FunkPercussion01	TranceFX03	Agogo02	SakataAgogo
FunkPercussion02	TranceFX04	ShakerShort	Elec9Clap
8BitFX01	TranceFX05	ShakerLong	626_TAM
8BitFX02	TrapFX01	NoClp	707_TAMB
8BitFX03	TrapFX02	SDS7_CLP	ABcowbell
HouseFX01	ElectricShaker	Soli909_CLAP	C78_Guiro
HouseFX02	ElectricCowbell	909Clp	808congalo
HouseFX03	DubstepFX01	808clp	808congame
HouseFX04	DubstepFX02	Abs	Y30ZAP2
HouseFX05	DubstepFX03	Abs5	X10_ZAP
HouseFX06	DubstepFX04	808congahi	
TranceFX01	DubstepFX05	808 claves	

SPECIFICATIONS

Configuration	3 X 8" Mesh Tom(with rim), 10" Mesh Snare (layered rims), 2 X 12" Crash Cymbal(with edge & choke), 12" Ride Cymbal(with edge & choke), 8" Hi-Hat, Hi-Hat Control Pedal, 8" Kick
Voice	697 High Quality Sounds
Drum Kit	20 Preset Kits and 20 User Kits
Pattern	55 Songs,Drum On/Off,Accomp On/Off
Sound Effect	Reverb,Compressor,Equalizer with Professional DSP Processor
Equalizer	4-Band Equalizer,Real-time Control
Metronome	On/Off,Tempo,Voice,Time Signature,TapTempo
SetupMenu	Back Volume,MasterTune,Local,Fader FX Setup, FaderM IDI Setup,Advanced(Sensitivity,Headroom,Trigger Curve,Auto Crosstalk,MIDI Note Send,Rim Velocity,Pedal,Split Point),Reset
PadEdit	Voice,Volume,Pan,Pitch,Reverb
Record	15 Songs
Display	Back-light LCD, 2 Row X16 Characters
Power	12V DC
Aux. Socket	Headphone,Line In, Line Out(L/R),USB, Power, External TriggerX2
New Feature	6 faders in three modes: Real-time pad volume control,FX control(Reverb, compressor and 4 -band equalizer),MIDI control. Kit with loop function. 5 step Hihat Pedal.

Specifications are subject to change without notice